

**P2 Relay V23079**

- Standard telecom relay (ringing and test access)
- Slim line 15x7.5mm (.590x.295")
- Max. switching current 5A
- 2 form C bifurcated contacts (2 changeover contacts, 2 CO)
- Immersion cleanable
- High sensitivity for low power consumption 140mW/ 70mW
- Single coil version with surge voltage resistance between contact and coil: 2.5kV (2/10µs) meets the Telcordia Requirement GR-1089, 1.5kV (10/160µs) meets FCC Part 68

Typical applications

Communications equipment linecard application (ringing and test access), PABX, voice over IP, office equipment, measurement and control equipment, automotive equipment as CAN bus, keyless entry, speaker switch, medical equipment, consumer electronics, set top boxes, HiFi

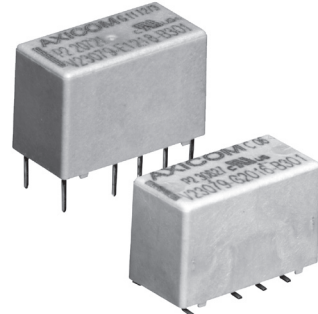

**Approvals**

UL 508 File No. E 111441, UL 60950, IEC/EN60950 IEC Ref. Cert. No. 327  
Technical data of approved types on request

**Contact Data**

|                                      |  |
|--------------------------------------|--|
| Contact arrangement                  | 2 form C (CO)  |
| Max. switching voltage               | 220VDC, 250VAC   |
| Rated current                        | 2A   |
| Limiting continuous current, 85°C    | 2A   |
| Switching Power                      | 60W, 62.5VA  |
| Contact material                     | AgNi, gold-covered   |
| Contact style                        | bifurcated contact   |
| Minimum switching voltage            | 100µV  |
| Thermo-electrical potential          | <10µV  |
| Initial contact resistance           | <50mΩ at 10mA, 20mV  |
| Frequency of operation, without load | 50 operations/s  |
| Operate time                         | typ. 2ms, max. 4ms   |
| Set/reset time                       | typ. 2ms, max. 4ms   |
| Release time                         |  |
| without diode in parallel            | typ. 2ms, max. 4ms   |
| with diode in parallel               | typ. 4ms, max. 6ms   |
| Bounce time                          | typ. 1ms, max. 3ms   |
| Electrical endurance                 |  |
| at 12V / 10mA                        | typ. 5x10 <sup>7</sup> operations  |
| at 6V / 100mA                        | typ. 1x10 <sup>7</sup> operations  |
| at 60V / 500mA                       | typ. 5x10 <sup>5</sup> operations  |
| at 30V / 1000mA                      | typ. 1x10 <sup>6</sup> operations  |
| at 30V / 2000mA                      | typ. 2x10 <sup>5</sup> operations  |
| Contact ratings, UL                  | 110VDC / 0.3A - 33W<br>30VDC / 2.0A - 60W<br>120VAC / 0.5A - 60VA<br>240VAC / 0.25A - 60VA |
| Mechanical endurance                 | typ. 100x10 <sup>6</sup> operations  |

**Coil Data**

|                       |            |
|-----------------------|------------|
| Magnetic system       | polarized  |
| Coil voltage range    | 2 to 24VDC |
| Max. coil temperature | 125°C      |
| Thermal resistance    | < 125K/W   |

**Coil versions, monostable**

| Coil code | Rated voltage VDC | Operate voltage VDC | Limiting Voltage VDC | Release voltage VDC | Coil resistance Ω±10% | Rated coil power mW |
|-----------|-------------------|---------------------|----------------------|---------------------|-----------------------|---------------------|
| 008       | 3.00              | 2.25                | 6.50                 | 0.30                | 64                    | 140                 |
| 016       | 4.00              | 3.00                | 8.70                 | 0.40                | 114                   | 140                 |
| 011       | 4.50              | 3.38                | 9.80                 | 0.45                | 145                   | 140                 |
| 001       | 5.00              | 3.75                | 10.90                | 0.50                | 178                   | 140                 |
| 002       | 6.00              | 4.50                | 13.00                | 0.60                | 257                   | 140                 |
| 006       | 9.00              | 6.75                | 19.60                | 0.90                | 578                   | 140                 |
| 003       | 12.00             | 9.00                | 26.15                | 1.20                | 1029                  | 140                 |
| 005       | 24.00             | 18.00               | 52.30                | 2.40                | 4114                  | 140                 |

All figures are given for coil without pre-energization, at ambient temperature +23°C. Other coil voltages on request.

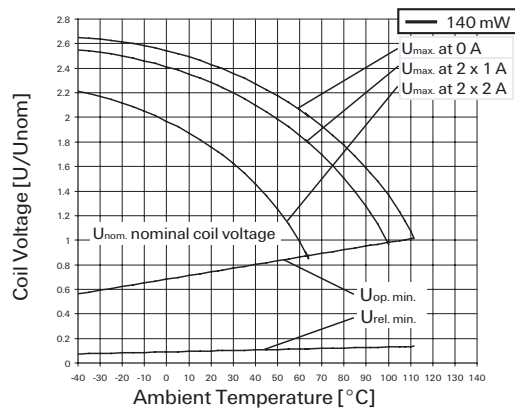

**Max. DC load breaking capacity**

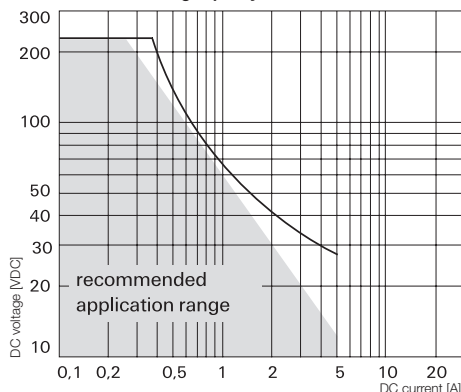

**P2 Relay V23079** (Continued)

**Coil Data** (continued)

**Coil versions, bistable**

| Coil code               | Rated voltage VDC | Set voltage VDC | Limiting Voltage VDC | Reset voltage VDC | Coil resistance $\Omega \pm 10\%$ | Rated coil power mW |
|-------------------------|-------------------|-----------------|----------------------|-------------------|-----------------------------------|---------------------|
| <b>Bistable, 1 coil</b> |                   |                 |                      |                   |                                   |                     |
| 108                     | 3.00              | 2.25            | 9.2                  | -2.25             | 128                               | 70                  |
| 111                     | 4.50              | 3.38            | 13.85                | -3.38             | 289                               | 70                  |
| 101                     | 5.00              | 3.75            | 15.33                | -3.75             | 357                               | 70                  |
| 102                     | 6.00              | 4.50            | 18.5                 | -4.50             | 514                               | 70                  |
| 106                     | 9.00              | 6.75            | 27.75                | -6.75             | 1157                              | 70                  |
| 103                     | 12.00             | 9.00            | 37                   | -9.00             | 2057                              | 70                  |
| 105                     | 24.00             | 18.00           | 74                   | -18.00            | 8228                              | 70                  |
| <b>Bistable, 2 coil</b> |                   |                 |                      |                   |                                   |                     |
| 219                     | 2.00              | 1.50            | 4.33                 | 1.50              | 28                                | 140                 |
| 218                     | 2.40              | 1.80            | 5.2                  | 1.80              | 41                                | 140                 |
| 208                     | 3.00              | 2.25            | 6.5                  | 2.25              | 64                                | 140                 |
| 211                     | 4.50              | 3.38            | 9.8                  | 3.38              | 145                               | 140                 |
| 201                     | 5.00              | 3.75            | 10.9                 | 3.75              | 178                               | 140                 |
| 202                     | 6.00              | 4.50            | 13                   | 4.50              | 257                               | 140                 |
| 206                     | 9.00              | 6.75            | 19.6                 | 6.75              | 578                               | 140                 |
| 203                     | 12.00             | 9.00            | 26.15                | 9.00              | 1029                              | 140                 |
| 205                     | 24.00             | 18.00           | 52.3                 | 18.00             | 4114                              | 140                 |

All figures are given for coil without pre-energization, at ambient temperature +23°C. Other coil voltages on request.

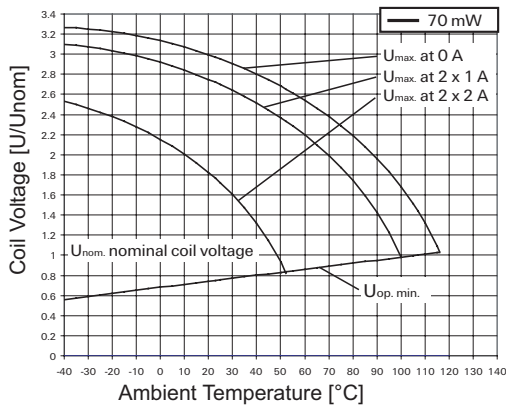

**Coil versions, high dielectric version, monostable, overmolded**

| Coil code | Rated voltage VDC | Operate voltage VDC | Limiting Voltage VDC | Release Voltage VDC | Coil resistance $\Omega \pm 10\%$ | Rated coil power mW |
|-----------|-------------------|---------------------|----------------------|---------------------|-----------------------------------|---------------------|
| 008       | 3.00              | 2.25                | 6.1                  | 0.30                | 45                                | 200                 |
| 001       | 5.00              | 3.75                | 10.1                 | 0.50                | 125                               | 200                 |
| 002       | 6.00              | 4.50                | 12.1                 | 0.60                | 180                               | 200                 |
| 006       | 9.00              | 6.75                | 18.2                 | 0.90                | 405                               | 200                 |
| 003       | 12.00             | 9.00                | 24.2                 | 1.20                | 720                               | 200                 |

All figures are given for coil without pre-energization, at ambient temperature +23°C. Other coil voltages on request.

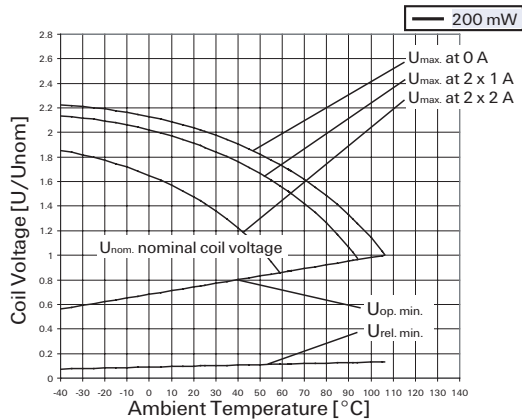

**Insulation Data**

|   | Standard              | HDV                  |
|---|-----------------------|----------------------|
| <b>Initial dielectric strength</b>              |                       |                      |
| between open contacts                           | 1000V <sub>rms</sub>  | 1500V <sub>rms</sub> |
| between contact and coil                        | 1500V <sub>rms</sub>  | 1500V <sub>rms</sub> |
| between adjacent contacts                       | 1000 V <sub>rms</sub> | 1500V <sub>rms</sub> |
| <b>Initial surge withstand voltage</b>          |                       |                      |
| according to Telcordia TR-NWT-001089 (2/10µs)   |                       |                      |
| between open contacts                           | 2000V                 | 2500V                |
| between contact and coil                        | 2500V                 | 2500V                |
| between adjacent contacts                       | 2500V                 | 2500V                |
| according to (10/700 µs IEC 60950)              |                       |                      |
| between open contacts                           | 2000V                 | 2500V                |
| between contact and coil                        | 2500V                 | 2500V                |
| between adjacent contacts                       | 2500V                 | 2500V                |
| <b>Initial insulation resistance at 500 Vdc</b> |                       |                      |
|   | > 10 <sup>9</sup> Ω   |                      |
| <b>Capacitance</b>                              |                       |                      |
| between open contacts                           | max. 1pF              |                      |
| between contact and coil                        | max. 2pF              |                      |
| between adjacent contacts                       | max. 1.5pF            |                      |
| <b>Clearance /creepage</b>                      |                       |                      |
| according to IEC / EN 60950                     | 1.3/2.5mm             |                      |

**Other Data**

Material compliance: EU RoHS/ELV, China RoHS, REACH, Halogen content refer to the Product Compliance Support Center at [www.te.com/customer-support/rohssupportcenter](http://www.te.com/customer-support/rohssupportcenter)

|  |                                       |
|--|---------------------------------------|
| Ambient temperature  | -40 to +85°C                          |
| Category of environmental protection IEC 61810   | RT III - wash tight                   |
| Degree of protection, IEC 60529  | IP 67                                 |
| Vibration resistance (functional)  | 35g, 10 to 1000Hz                     |
| Shock resistance (functional) IEC 60068-2-27 (half sine)   | 100g                                  |
| Terminal type  | PCB-THT, SMT long and short terminals |
| Weight   | max. 2.8 g                            |
| Resistance to soldering heat THT IEC 60068-2-20  | 265°C/10s                             |
| Moisture sensitive level, JEDEC J-Std-020D related only to SMT relays packed in original dry-packs | MSL3                                  |
| Ultrasonic cleaning  | not recommended                       |
| <b>Packaging/unit</b>  |                                       |
| THT  | box/2000 pcs.                         |
| SMT  | reel/2000 pcs. or 2500 pcs.           |

**P2 Relay V23079** (Continued)

**Terminal assignment**

TOP view on component side of PCB

Monostable version



ECR0912-C

Bistable version, 1-coil

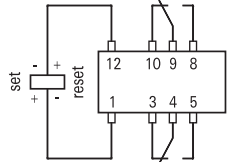

ECR0912-C

Bistable version, 2-coils

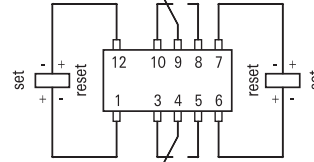

ECR0913-K

Contacts are shown in reset condition.  
Both coils can be used as either set or reset coils.  
Contact position might change during transportation and must be reset before use.

**PCB layout**

TOP view on component side of PCB

THT version

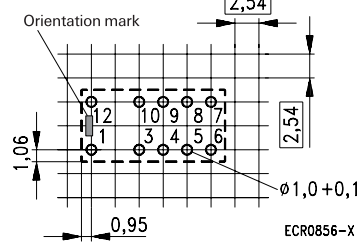

ECR0856-X

SMT, long terminals

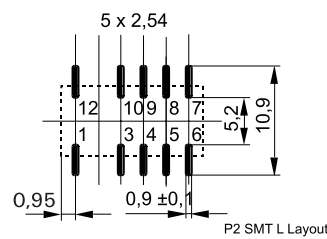

P2 SMT L Layout

SMT, short terminals

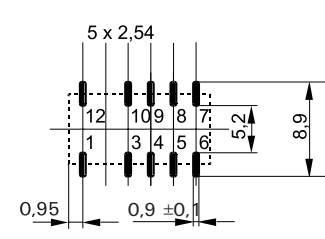

**Dimensions**

Standard coil

THT version

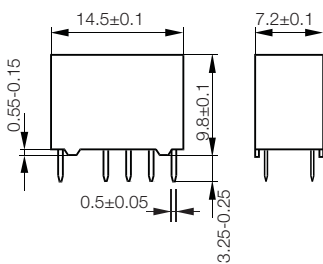

SMT, long terminals

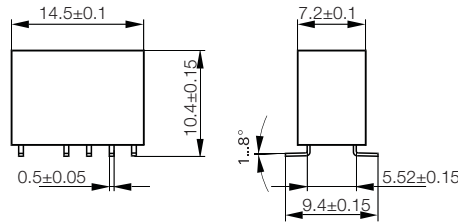

SMT, short terminals

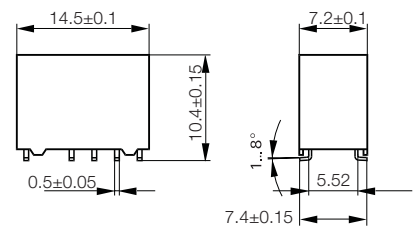

Overmolded coil, high dielectric version

THT version

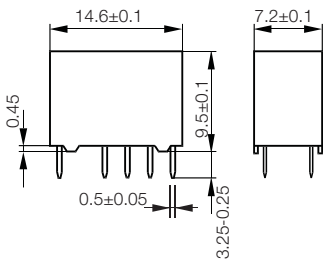

SMT, long terminals

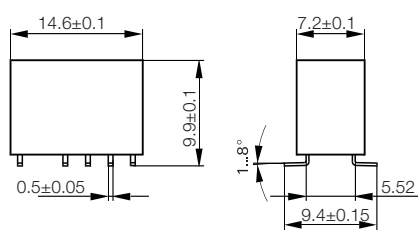

SMT, short terminals

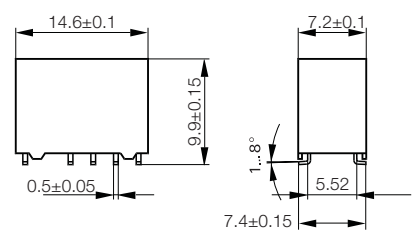

**P2 Relay V23079** (Continued)

**Processing**

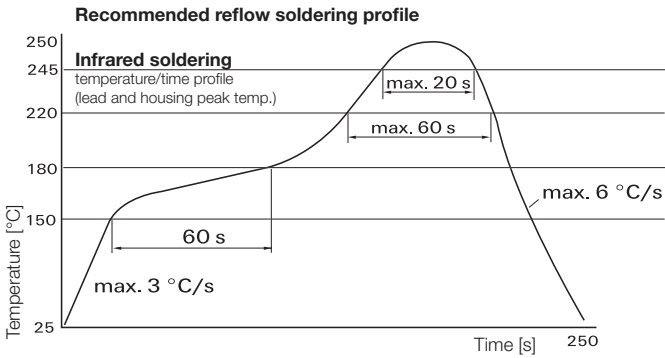
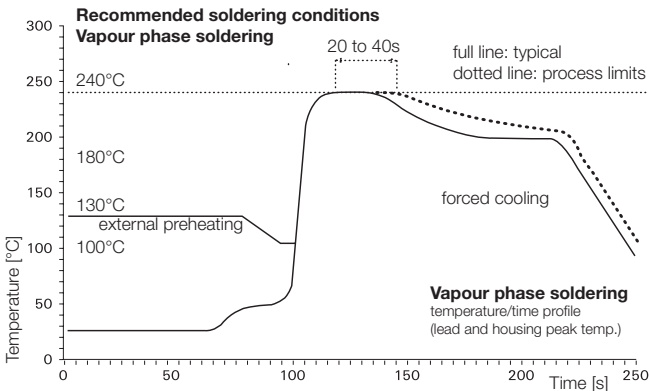

**Packing**

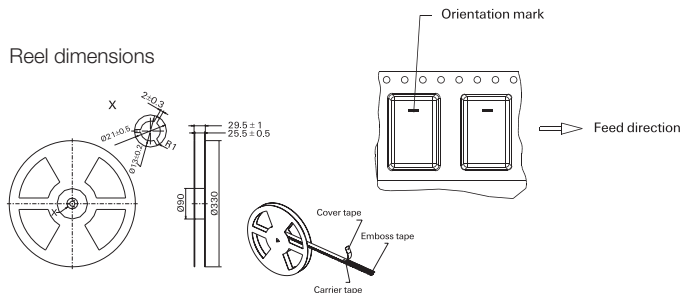
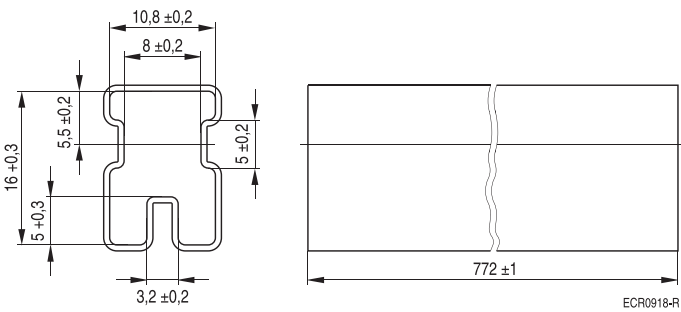

**P2 Relay V23079 (Continued)**

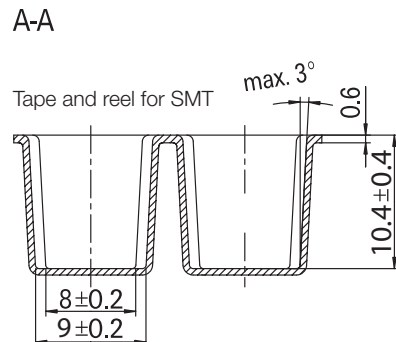
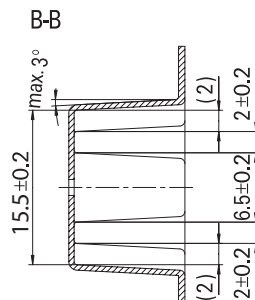
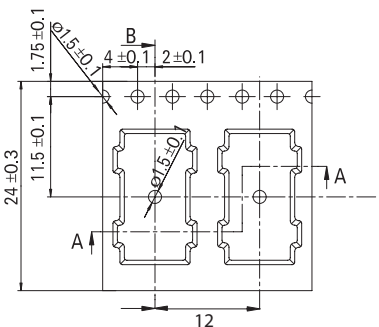
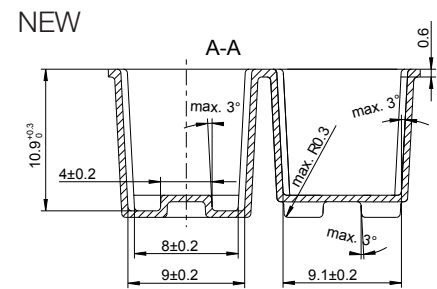
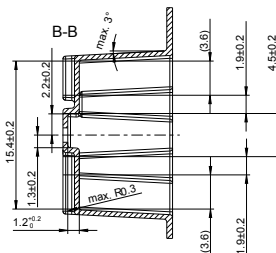
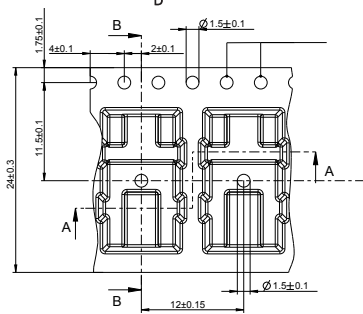
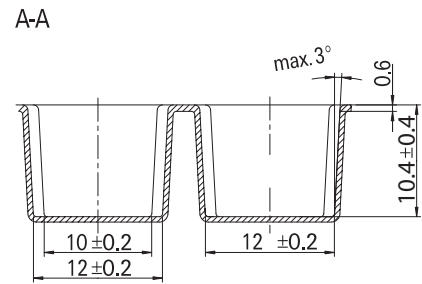
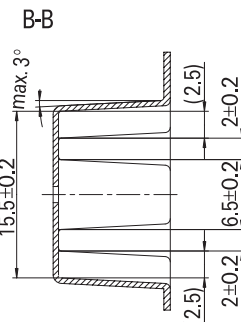
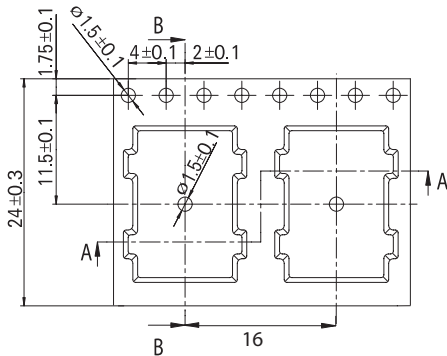
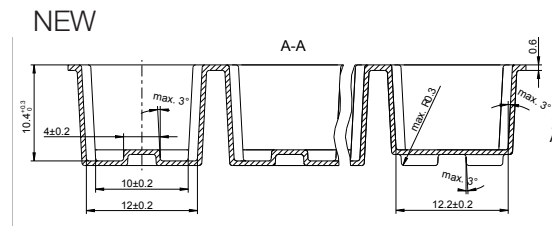
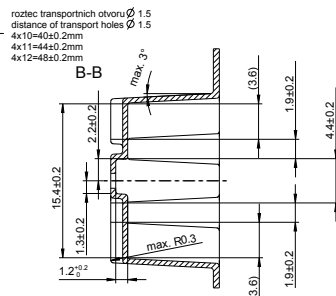
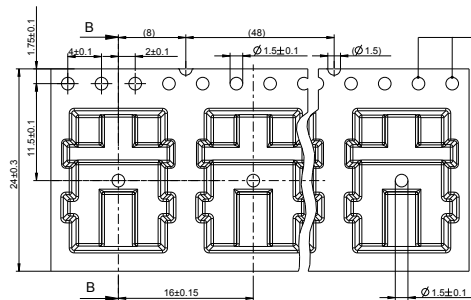
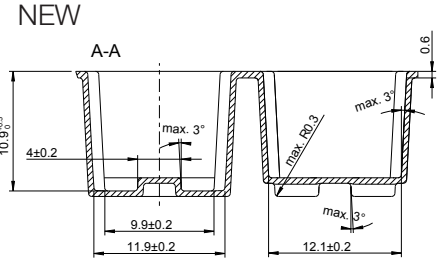
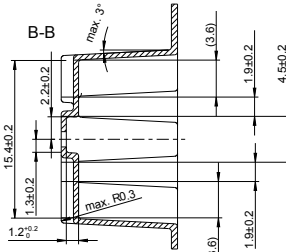
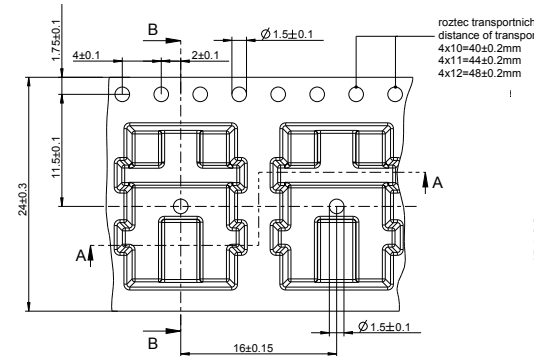

**P2 Relay V23079** (Continued)

|   |   |                      |                                   |               |                                    |          |            |          |            |
|---|---|----------------------|-----------------------------------|---------------|------------------------------------|----------|------------|----------|------------|
| <b>Product code structure</b>                                 |   | Typical product code |                                   | <b>V23079</b> | <b>A</b>                           | <b>1</b> | <b>001</b> | <b>B</b> | <b>301</b> |
| <b>Type</b><br>V23079 Signal Relay P2 Series                  |   |                      |                                   |               |                                    |          |            |          |            |
| <b>Version</b>  |   |                      |                                   |               |                                    |          |            |          |            |
| <b>A</b>  | THT, monostable                                     | <b>D</b>             | SMT, monostable, long term.       | <b>G</b>      | SMT, monostable, short term.       |          |            |          |            |
| <b>B</b>  | THT, latching, 2 coils                              | <b>E</b>             | SMT, latching, 2 coils long term. | <b>H</b>      | SMT, latching, 2 coils short term. |          |            |          |            |
| <b>C</b>  | THT, latching, 1 coil                               | <b>F</b>             | SMT, latching, 1 coil long term.  | <b>J</b>      | SMT, latching, 1 coil short term.  |          |            |          |            |
| <b>Coil design</b>  |   |                      |                                   |               |                                    |          |            |          |            |
| <b>1</b>  | Standard coil (not for high dielectric version)     |                      |                                   |               |                                    |          |            |          |            |
| <b>2</b>  | Overmolded coil                                     |                      |                                   |               |                                    |          |            |          |            |
| <b>Coil</b><br>Coil code: please refer to coil versions table |   |                      |                                   |               |                                    |          |            |          |            |
| <b>Version</b>  |   |                      |                                   |               |                                    |          |            |          |            |
| <b>B</b>  | Standard version                                    |                      |                                   |               |                                    |          |            |          |            |
| <b>X</b>  | High dielectric version                             |                      |                                   |               |                                    |          |            |          |            |
| <b>Contacts</b> for standard versions                         |   |                      |                                   |               |                                    |          |            |          |            |
| <b>301</b>  | 2 form C contacts (2 CO), AgNi +Au                  |                      |                                   |               |                                    |          |            |          |            |
| <b>201</b>  | 2 form C contacts (2 CO), AgPd +Au; on request only |                      |                                   |               |                                    |          |            |          |            |

| Product code      | Version | Coil design | Coil type         | Coil voltage | Part number |
|-------------------|---------|-------------|-------------------|--------------|-------------|
| V23079-A1006-B301 |         |             |                   | 9VDC         | 2-1393788-0 |
| V23079-A1005-B301 |         |             |                   | 24VDC        | 1-1393788-6 |
| V23079-A2008-B301 |         | Overmolded  |                   | 3VDC         | 6-1419120-6 |
| V23079-A2011-B301 |         |             | 4.5VDC            | 3-1393789-9  |             |
| V23079-A2001-B301 |         |             |                   | 5VDC         | 3-1393789-5 |
| V23079-A2002-B301 |         |             |                   | 6VDC         | 3-1393789-6 |
| V23079-A2006-B301 |         |             |                   | 9VDC         | 3-1393789-8 |
| V23079-A2003-B301 |         |             |                   | 12VDC        | 3-1393789-7 |
| V23079-B1218-B301 |         | Standard    | Bistable, 2 coils | 2.4VDC       | 1422002-8   |
| V23079-B1208-B301 |         |             |                   | 3VDC         | 4-1393788-1 |
| V23079-B1211-B301 |         |             |                   | 4.5VDC       | 4-1393788-2 |
| V23079-B1201-B301 |         |             |                   | 5VDC         | 3-1393788-3 |
| V23079-B1202-B301 |         |             |                   | 6VDC         | 3-1393788-5 |
| V23079-B1206-B301 |         |             |                   | 9VDC         | 3-1393788-9 |
| V23079-B1203-B301 |         |             |                   | 12VDC        | 3-1393788-6 |
| V23079-B1205-B301 |         |             |                   | 24VDC        | 3-1393788-7 |
| V23079-B2219-B301 |         | Overmolded  |                   | 2VDC         | 1-1422002-2 |
| V23079-B2218-B301 |         |             | 2.4VDC            | 1-1422002-1  |             |
| V23079-B2208-B301 |         |             |                   | 3VDC         | 1-1422002-0 |
| V23079-B2201-B301 |         |             |                   | 5VDC         | 1422002-9   |
| V23079-C1108-B301 |         | Standard    | Bistable, 1 coils | 3VDC         | 5-1393788-3 |
| V23079-C1111-B301 |         |             |                   | 4.5VDC       | 5-1393788-4 |
| V23079-C1101-B301 |         |             |                   | 5VDC         | 4-1393788-5 |
| V23079-C1102-B301 |         |             |                   | 6VDC         | 4-1393788-7 |
| V23079-C1106-B301 |         |             |                   | 9VDC         | 5-1393788-1 |
| V23079-C1103-B301 |         |             |                   | 12VDC        | 4-1393788-8 |
| V23079-C1105-B301 |         |             |                   | 24VDC        | 5-1393788-0 |

**P2 Relay V23079** (Continued)

| Product code      | Version         | Coil design     | Coil type         | Coil voltage | Part number |
|-------------------|-----------------|-----------------|-------------------|--------------|-------------|
| V23079-D1006-B301 |                 |                 |                   | 9VDC         | 5-1393788-9 |
| V23079-D1005-B301 |                 |                 |                   | 24VDC        | 5-1393788-8 |
| V23079-D2008-B301 |                 | Overmolded      |                   | 3VDC         | 4-1393789-7 |
| V23079-D2011-B301 |                 |                 |                   | 4.5VDC       | 4-1393789-8 |
| V23079-D2001-B301 |                 |                 |                   | 5VDC         | 4-1393789-3 |
| V23079-D2002-B301 |                 |                 |                   | 6VDC         | 4-1393789-4 |
| V23079-D2006-B301 |                 |                 |                   | 9VDC         | 4-1393789-6 |
| V23079-D2003-B301 |                 |                 |                   | 12VDC        | 4-1393789-5 |
| V23079-E1219-B301 |                 | Standard        | Bistable, 2 coils | 2VDC         | 1-1422007-0 |
| V23079-E1218-B301 |                 |                 |                   | 2.4VDC       | 1422007-5   |
| V23079-E1208-B301 |                 |                 |                   | 3VDC         | 7-1393788-1 |
| V23079-E1211-B301 |                 |                 |                   | 4.5VDC       | 7-1393788-2 |
| V23079-E1201-B301 |                 |                 |                   | 5VDC         | 6-1393788-8 |
| V23079-E1202-B301 |                 |                 |                   | 6VDC         | 1393789-5   |
| V23079-E1206-B301 |                 |                 |                   | 9VDC         | 1393789-9   |
| V23079-E1203-B301 |                 |                 |                   | 12VDC        | 6-1393788-9 |
| V23079-E1205-B301 |                 |                 |                   | 24VDC        | 7-1393788-0 |
| V23079-E2219-B301 |                 | Overmolded      |                   | 2VDC         | 1422007-6   |
| V23079-E2201-B301 |                 |                 |                   | 5VDC         | 1422007-7   |
| V23079-E2208-B301 |                 |                 |                   | 3VDC         | 1422007-8   |
| V23079-E2218-B301 |                 |                 |                   | 2.4VDC       | 1422007-9   |
| V23079-F1108-B301 |                 | Standard        | Bistable, 1 coil  | 3VDC         | 7-1393788-5 |
| V23079-F1111-B301 |                 |                 |                   | 4.5VDC       | 1-1393789-4 |
| V23079-F1101-B301 |                 |                 |                   | 5VDC         | 7-1393788-3 |
| V23079-F1102-B301 |                 |                 |                   | 6VDC         | 1-1393789-0 |
| V23079-F1106-B301 |                 |                 |                   | 9VDC         | 1-1393789-2 |
| V23079-F1103-B301 |                 |                 |                   | 12VDC        | 7-1393788-4 |
| V23079-F1105-B301 |                 |                 |                   | 24VDC        | 1-1393789-1 |
| V23079-G1005-B301 | SMT, short pins |                 | Monostable        | 24VDC        | 7-1393788-8 |
| V23079-G2008-B301 |                 | Overmolded      |                   | 3VDC         | 5-1393789-4 |
| V23079-G2016-B301 |                 |                 |                   | 4VDC         | 1393790-5   |
| V23079-G2011-B301 |                 |                 |                   | 4.5VDC       | 5-1393789-5 |
| V23079-G2001-B301 |                 |                 |                   | 5VDC         | 4-1393789-9 |
| V23079-G2002-B301 |                 |                 |                   | 6VDC         | 5-1393789-0 |
| V23079-G2006-B301 |                 |                 |                   | 9VDC         | 5-1393789-3 |
| V23079-G2003-B301 |                 |                 |                   | 12VDC        | 5-1393789-1 |
| V23079-H1208-B301 |                 | Standard        | Bistable, 2 coils | 3VDC         | 2-1393789-4 |
| V23079-H1211-B301 |                 |                 |                   | 4.5VDC       | 8-1393788-4 |
| V23079-H1201-B301 |                 |                 |                   | 5VDC         | 2-1393789-0 |
| V23079-H1202-B301 |                 |                 |                   | 6VDC         | 2-1393789-1 |
| V23079-H1206-B301 |                 |                 |                   | 9VDC         | 2-1393789-3 |
| V23079-H1203-B301 |                 |                 |                   | 12VDC        | 8-1393788-3 |
| V23079-H1205-B301 |                 |                 |                   | 24VDC        | 2-1393789-2 |
| V23079-J1108-B301 |                 |                 | Bistable, 1 coil  | 3VDC         | 2-1393789-9 |
| V23079-J1111-B301 |                 |                 |                   | 4.5VDC       | 3-1393789-0 |
| V23079-J1101-B301 |                 |                 |                   | 5VDC         | 2-1393789-5 |
| V23079-J1102-B301 |                 |                 |                   | 6VDC         | 2-1393789-6 |
| V23079-J1103-B301 |                 |                 |                   | 12VDC        | 2-1393789-7 |
| V23079-J1105-B301 |                 |                 |                   | 24VDC        | 2-1393789-8 |
| V23079-G2008-X079 |                 | High dielectric | Monostable        | 3VDC         | 1422006-5   |
| V23079-G2001-X071 |                 | Overmolded      |                   | 5VDC         | 1422006-1   |
| V23079-G2002-X072 |                 |                 |                   | 6VDC         | 1422006-2   |
| V23079-G2006-X073 |                 |                 |                   | 9VDC         | 1422006-3   |
| V23079-G2003-X074 |                 |                 |                   | 12VDC        | 1422006-4   |
| V23079-A2003-X074 |                 |                 |                   | 12VDC        | 1422025-7   |
| V23079-A2008-X079 |                 |                 |                   | 3VDC         | 1-1422025-1 |